



Scan QR Code for installation and operation manual



60" SUMMIT OPEN LINEAR LUXURY FIREPLACE

UNIT PHYSICAL DIMENSIONS

Front Width: 66"

Height: 46 3/4"

Depth: 22"

BTUs: SML-60BR-VEN (NG): 50,000 - 75,000
 SML-60BR-VEP (LP): 40,000 - 75,000
 SML-60BRT-VEN (NG): 60,000 - 95,000
 SML-60BRT-VEP (LP): 40,000 - 85,000

FRONT PHYSICAL DIMENSIONS

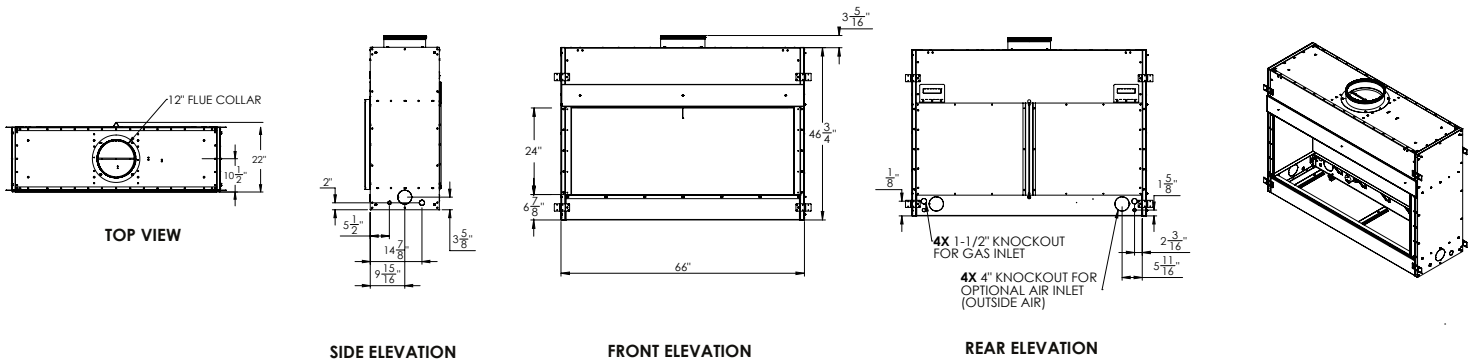

FIREPLACE BURNER OPTIONS

BEDROCK CONTEMPORARY



Must add 1/2" reflective glass or lava granules (5 lbs/foot)
 — Optional
 6" Cannonballs in black, gray, or white
 60" Western Driftwood Linear Log Set, 11 pieces

BEDROCK TRADITIONAL WITH GLOWFIRE™ LOGS



Must add 1/2" reflective glass or lava granules (5 lbs/foot)
 Driftwood GlowFire™ logs included.

FIREPLACE PANELS

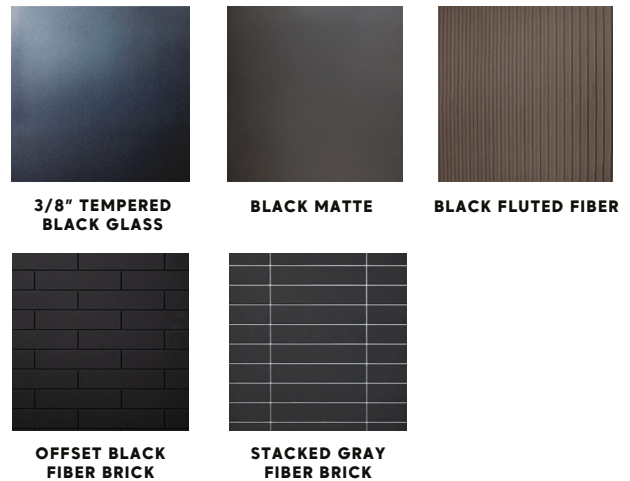

VIEWING REDUCTION KIT

Viewing reduction kits are available as an add-on to reduce the viewing area by 6" in height, from 24" to 18" high. The kit included the firebox reduction panel and side drywall stops.

*If installing as a corner view or bay corner(s), reduction kits are required.

OPTIONAL POWER VENT KIT

Power vent kits are available as an add-on to provide greater flexibility in fireplace placement and vent routing, while ensuring safe and efficient operation.

FRONT VIEW

FRAMING DIMENSIONS

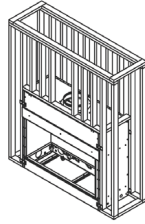

Width: 66 3/8" | Height: 47" | Depth: 22" | Weight: 355 lbs

Bottom to Drywall Stop: 6 3/4" | Viewing Area: 62 1/2"

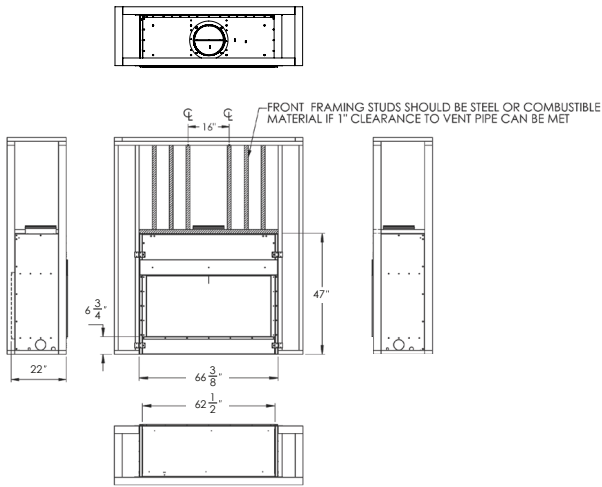

LEFT VIEW

FRAMING DIMENSIONS

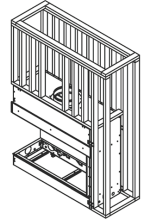

Reverse for right view

Width: 65" | Height: 47" | Depth: 22" | Weight: 355 lbs

Bottom to Drywall Stop: 6 3/4" | Viewing Area: 63"

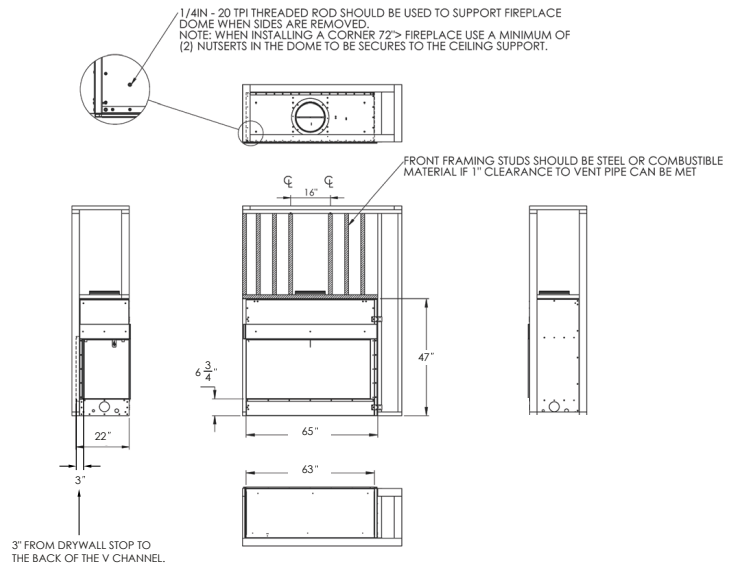

BAY VIEW

FRAMING DIMENSIONS

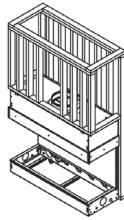

Width: 63 3/4" | Height: 47" | Depth: 22" | Weight: 355 lbs

Bottom to Drywall Stop: 6 3/4" | Viewing Area: 63 5/8"

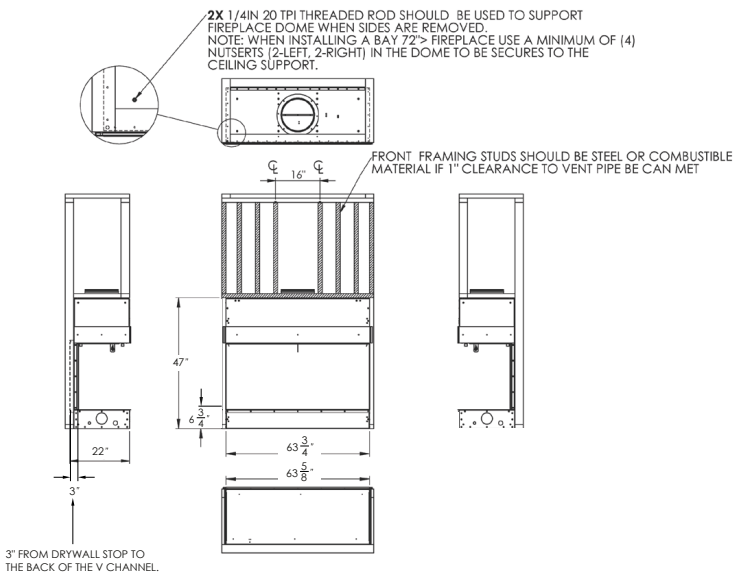

CORNER VIEW

FRAMING DIMENSIONS

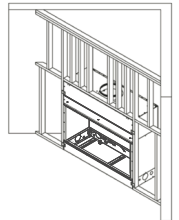

Width: 66 3/8" | Height: 47" | Wall to Wall: 109 3/4" | Weight: 355 lbs

Bottom to Drywall Stop: 6 3/4" | Viewing Area: 62 1/2" | Angle Length: 77 1/8"

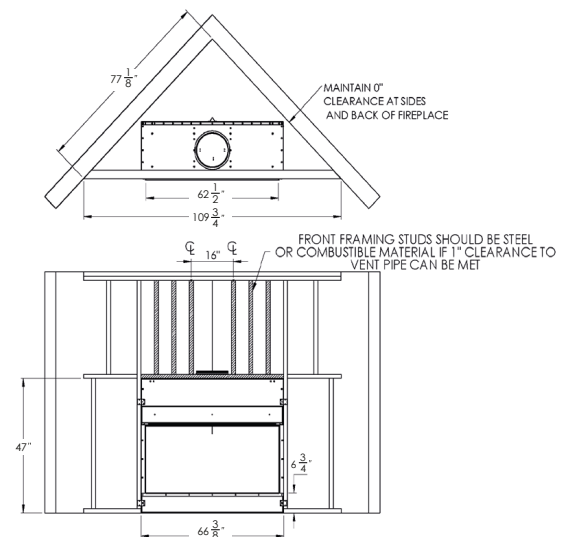

MINIMUM CLEARANCE TO COMBUSTIBLES

Back and sides of fireplaces	0" minimum
Floor	0" minimum
Perpendicular wall to opening	19" minimum
Top of fireplace	0" or top of studs minimum
Chimney outer pipe surface	1" minimum

VENTING

- 12" B-Vent
- *Minimum Height 14"
- *No more than two 45° offsets

*Unless using power vent

MANTEL CLEARANCES

A combustible mantle shelf may be installed a maximum of 8" (20.3 cm) from the wall.

A combustible mantle shelf may be installed at a minimum of 6" above the opening of the fireplace and a maximum of 8" from the wall.

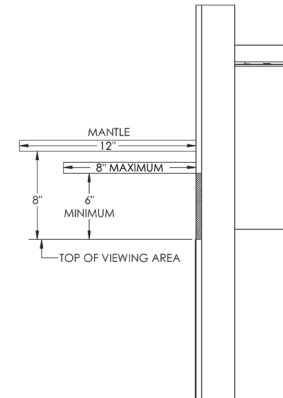

REQUIREMENTS FOR TV INSTALLATION

You can safely place a TV above the Summit fireplace, but the required clearance will depend on the TV manufacturer's guidelines.

When installing a TV 18" above the opening of the fireplace a mantel for heat deflection is required. If installing a TV 18" or more above the opening please refer to the TV manufacturer's required clearances guideline.



PRODUCT CODES

USA	ANSI Z21.50.2019
CAN	CSA 2.22.2019

MAKEUP-AIR REQUIREMENTS

SUMMIT SIZE	CONFIGURATION	CFM
60"	Front View	512
60"	Corner View	681
60"	Bay View	849

The product information provided is not complete and is subject to change without notice.

To avoid the risk of fire and potential injury, product installation must adhere strictly to instructions contained in the Installation and Operation Manual.